

Burke

1.1m Clamp On Pedestrian Arm

Part #: S15-50-COQ-E001

TOTAL WEIGHT (KG): 12.09

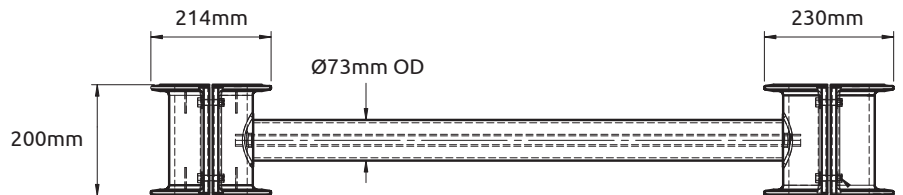
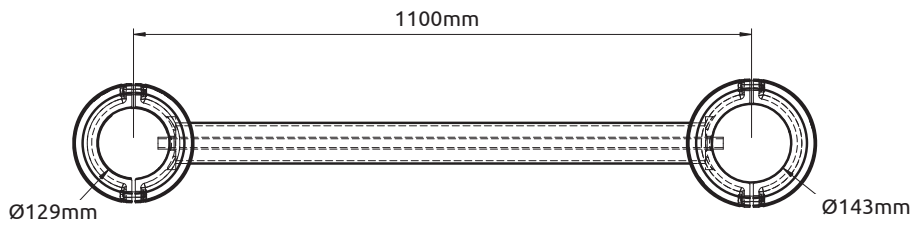

Size Chart

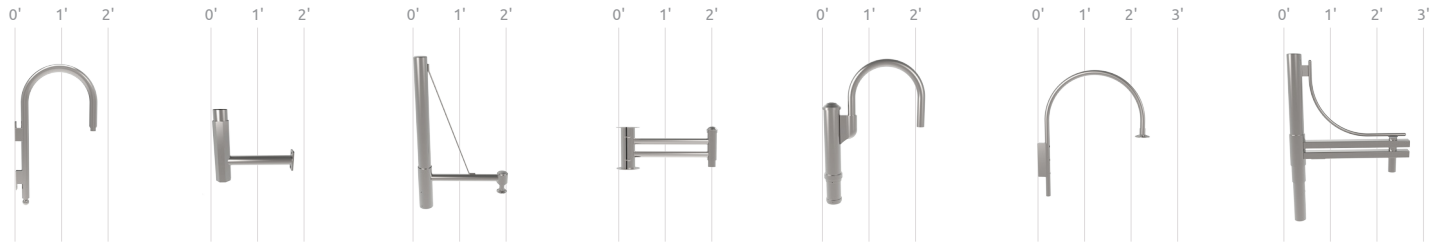

Shepherd 2

Westminster

Long Bay

Ponderosa

Shepherd 3

Shepherd 1

Marina

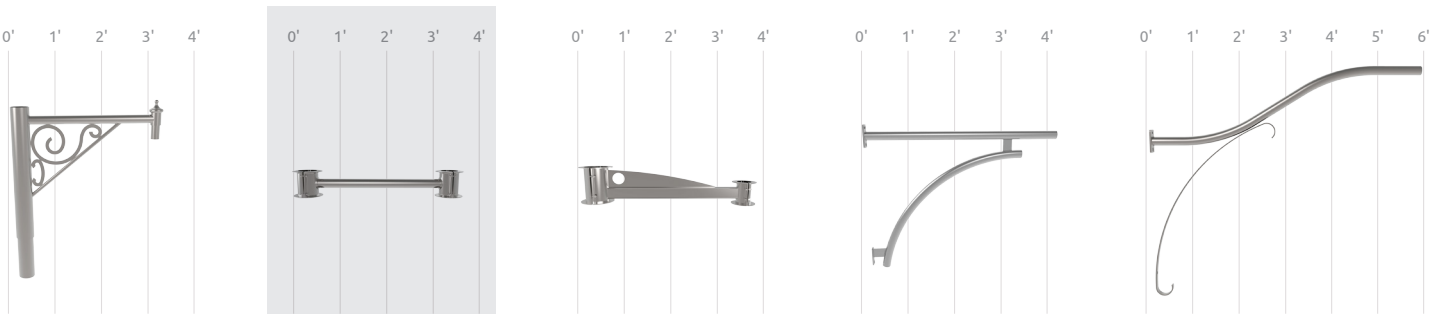

Vernon

Burke

Riverside

Heritage

Hodgson

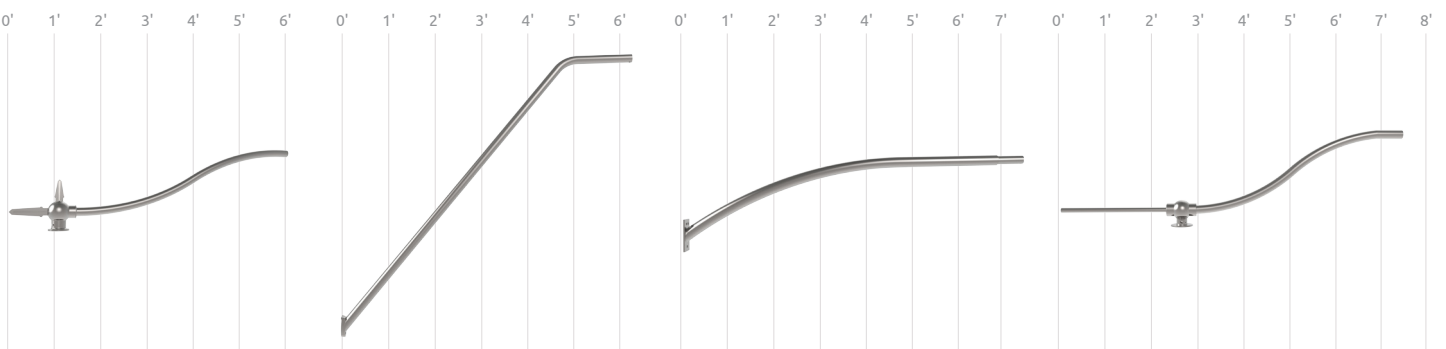

Scroll 2

Kansas

Lima

Bronte

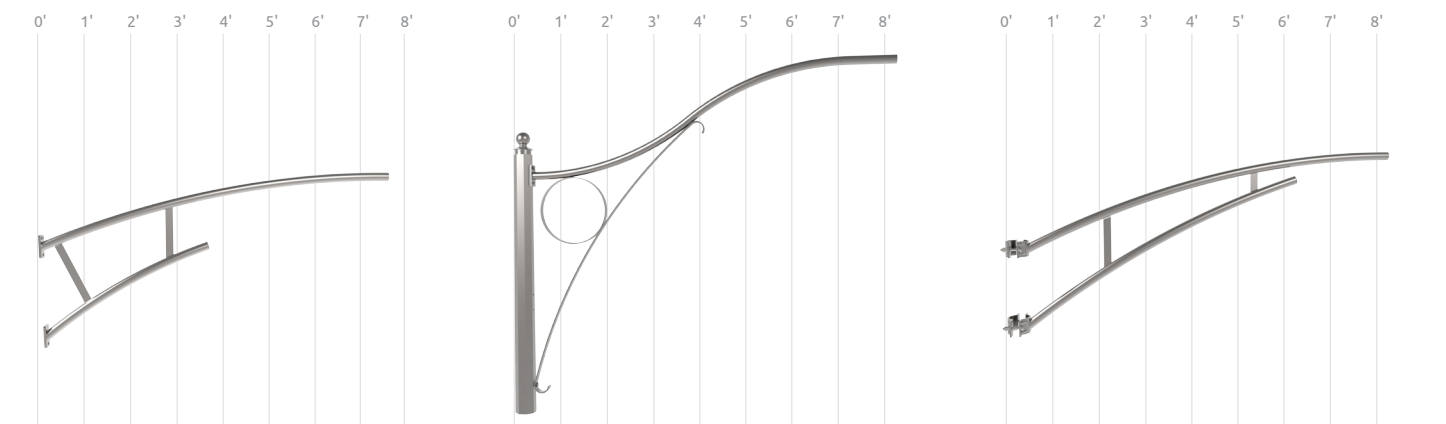

Newport

Scroll 1

Truss 1

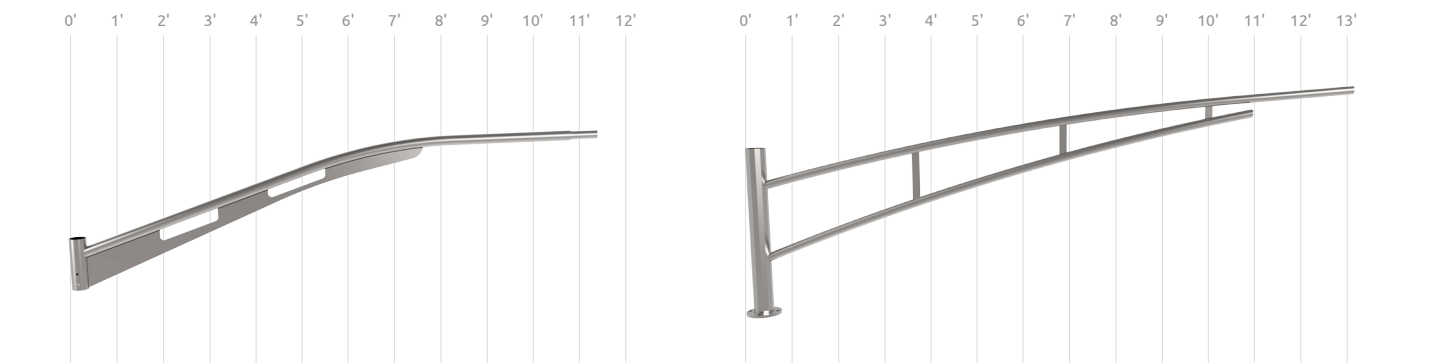

Gullwing

Truss 2