

Hodgson

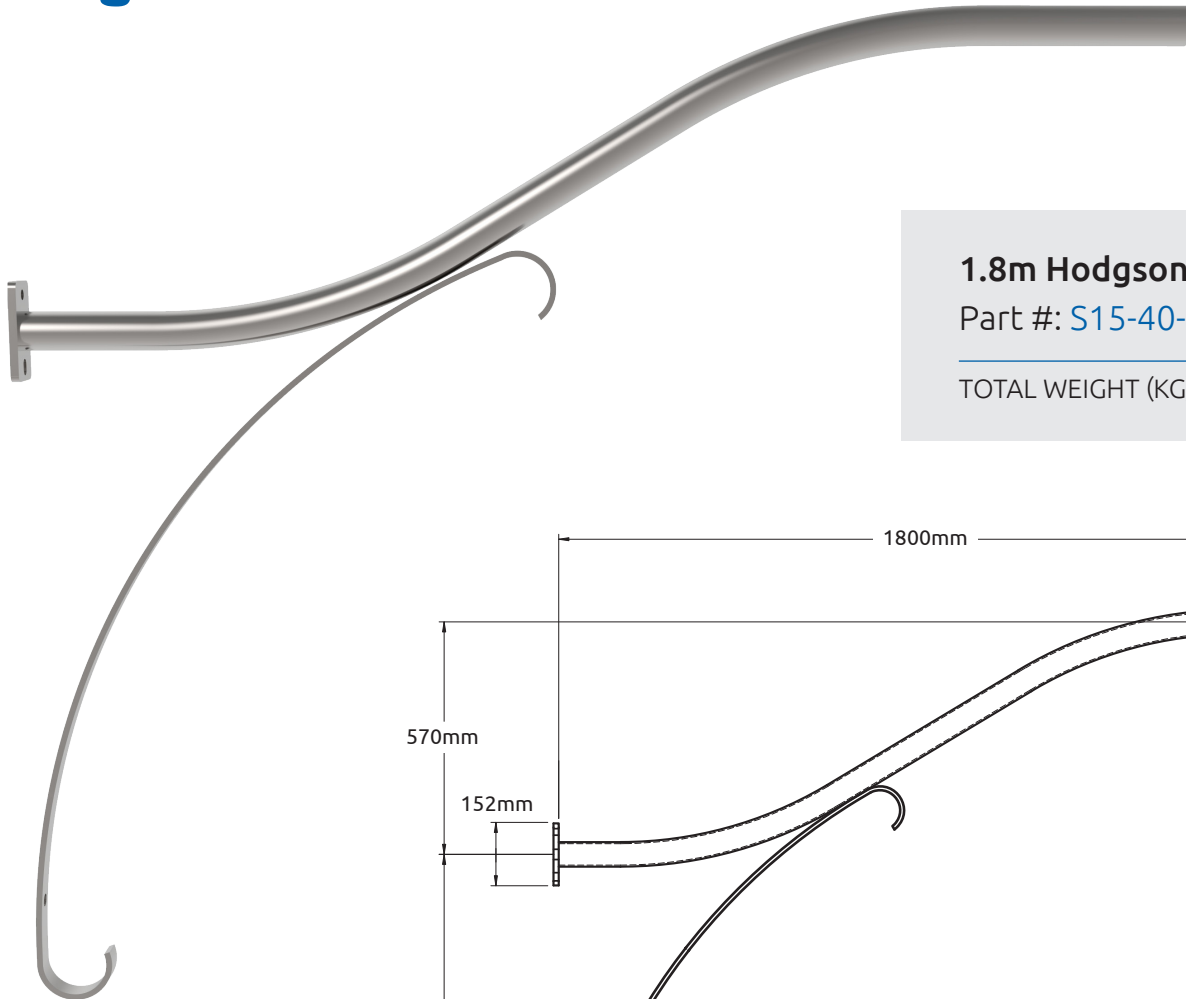

1.8m Hodgson Arm

Part #: [S15-40-18HD-001](#)

TOTAL WEIGHT (KG): 18.13

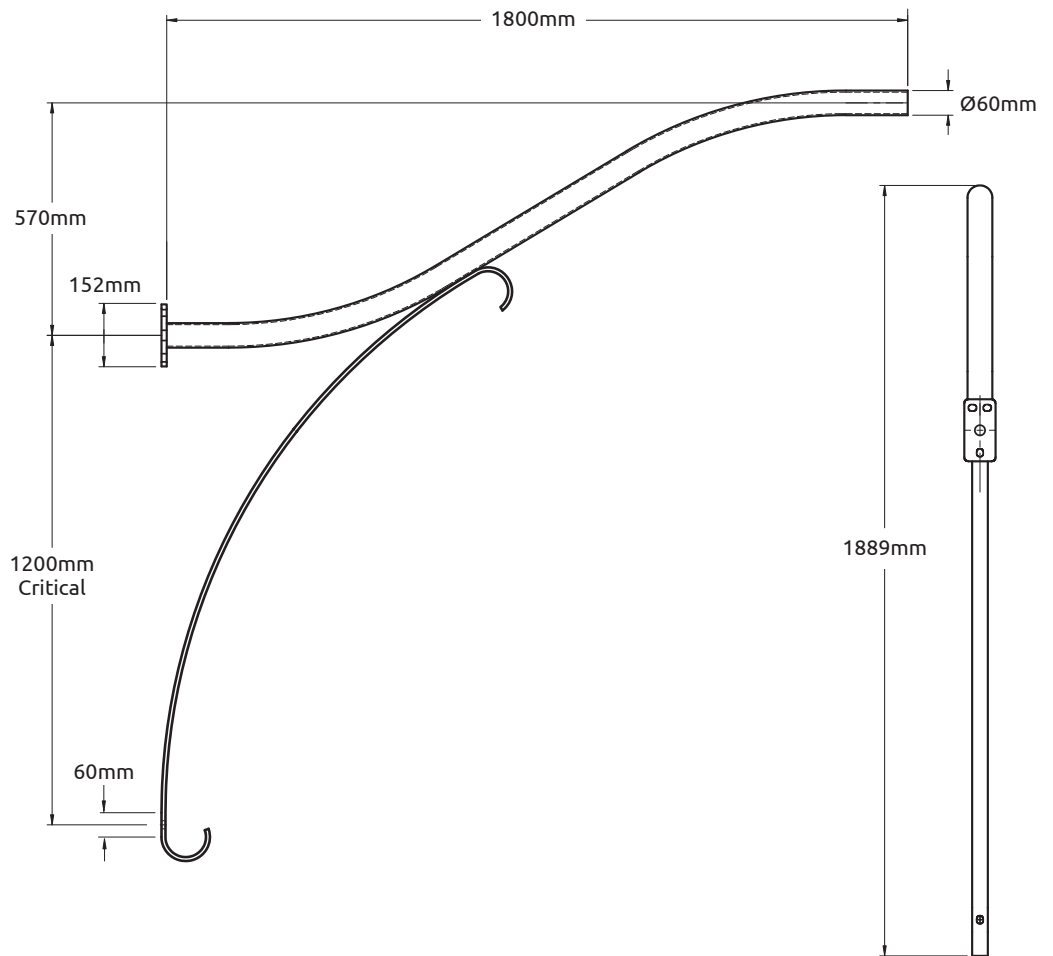

Size Chart

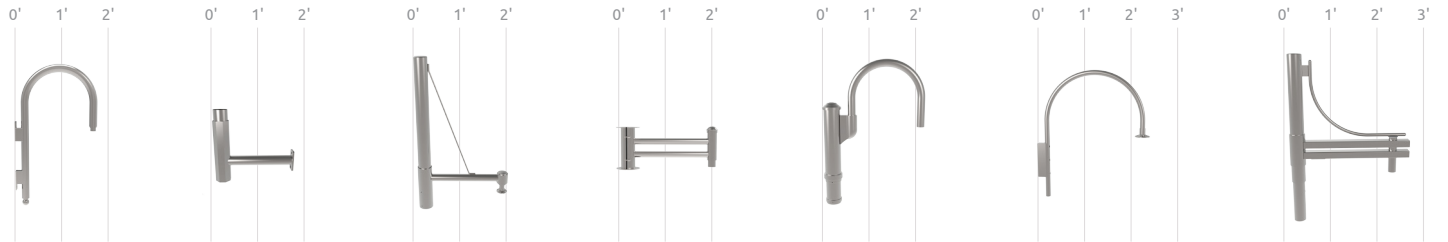

Shepherd 2

Westminster

Long Bay

Ponderosa

Shepherd 3

Shepherd 1

Marina

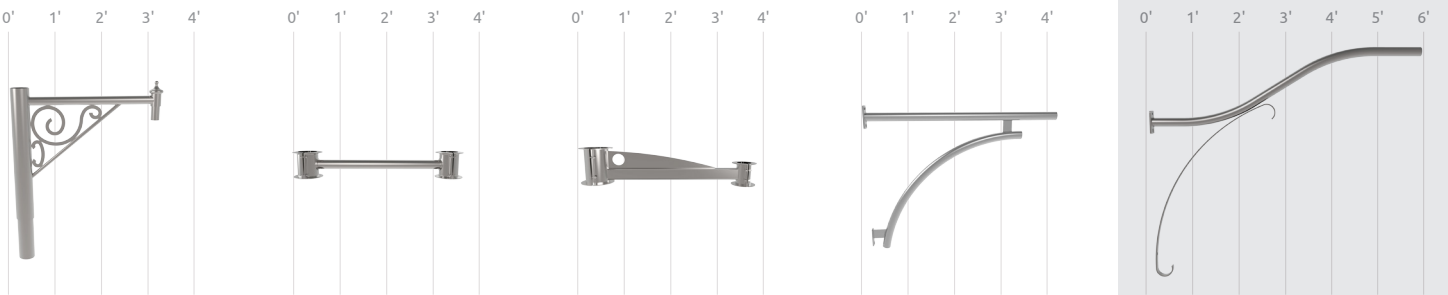

Vernon

Burke

Riverside

Heritage

Hodgson

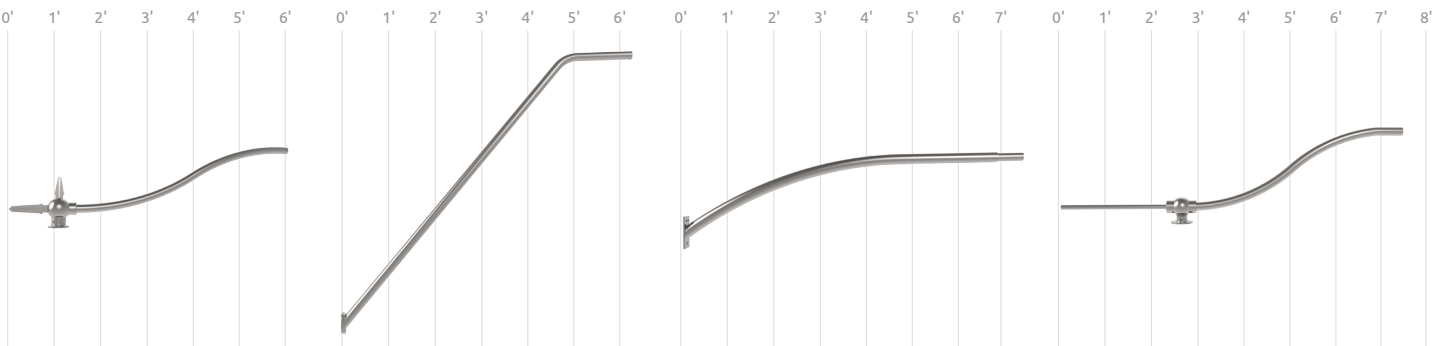

Scroll 2

Kansas

Lima

Bronte

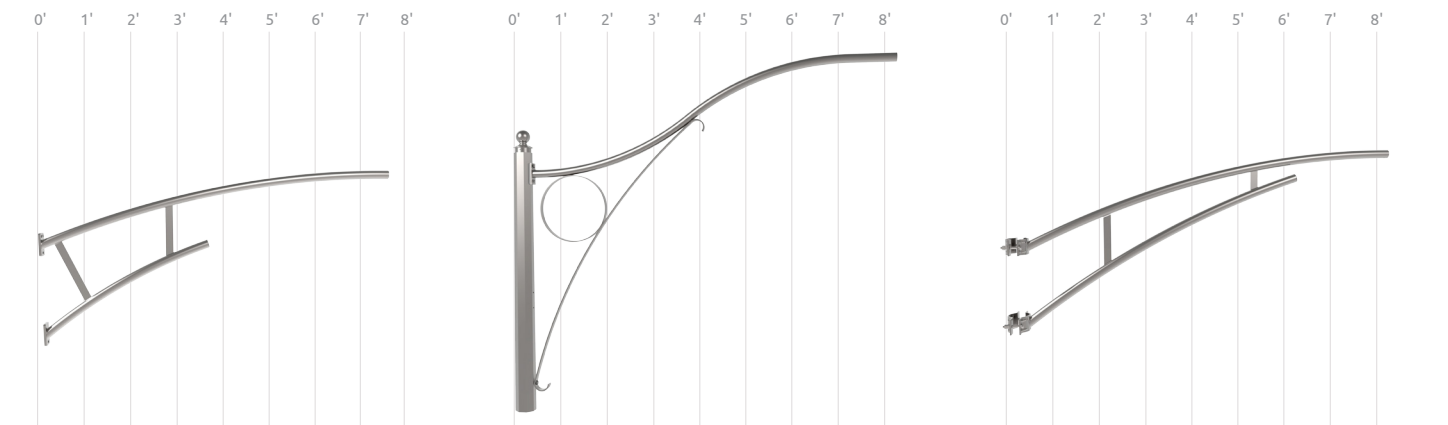

Newport

Scroll 1

Truss 1

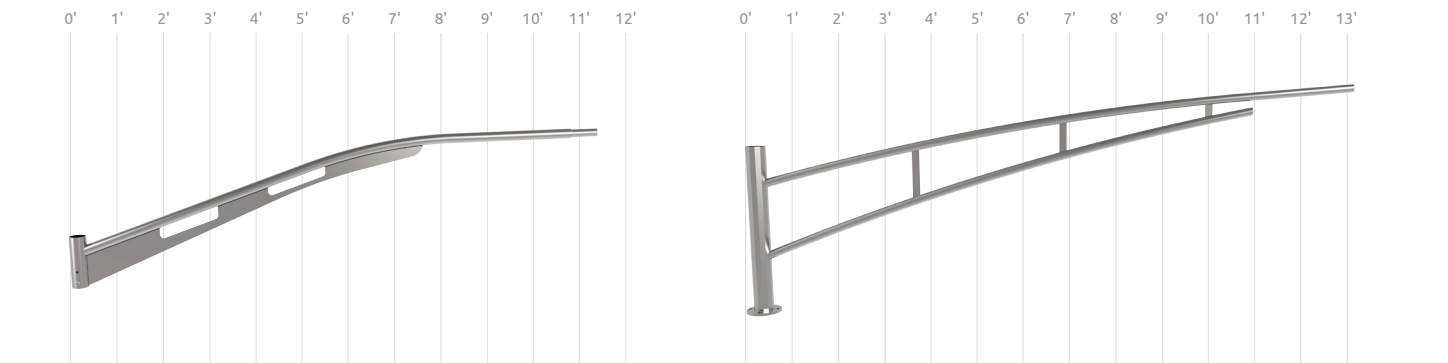

Gullwing

Truss 2