

Round Tapered Steel

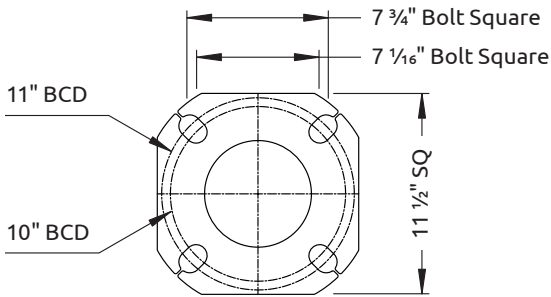

NRT Type A

(1" Anchor Bolts)

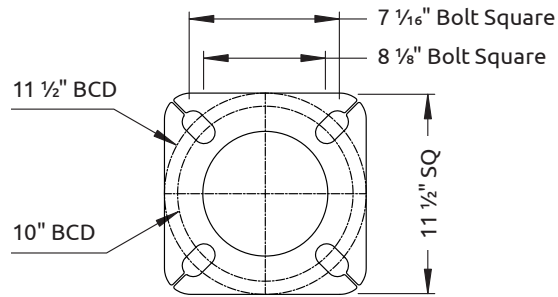

NRT Type B

(1" Anchor Bolts)

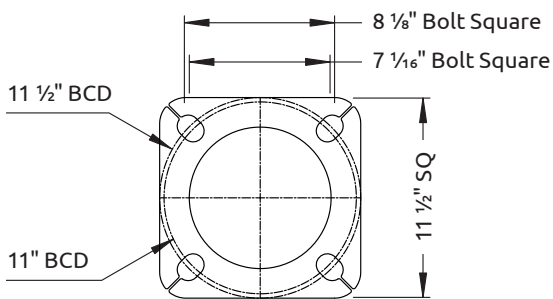

NRT Type C

(1" Anchor Bolts)

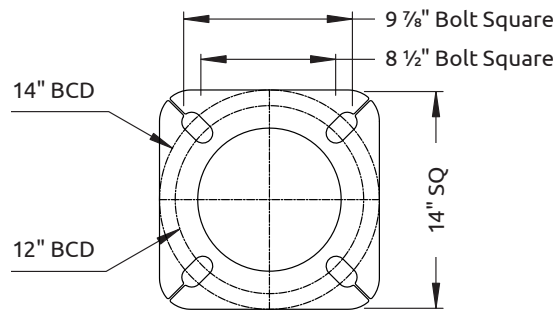

NRT Type D



(1" Anchor Bolts)

- Hand hole ring mounting height is 12" to centre and comes with (4"x7") hand hole cover
- Wind speeds (mph) in the table denote the maximum wind gust speed at the project site (i.e. gust factor included).
- Maximum EPA rating includes fixture(s) and supporting arm(s) and is for standard pole installation on concrete bases/footings.
- All poles are supplied with nut covers, shims and top plastic cap.
- Pole designs based on AASHTO Standard Specifications for Structural Supports for Highway Signs, Luminaires, and Traffic Signals.
- Contact Sales Team for custom sizes and/or applications.
- Specific information and details may be subject to change without notice.
- Please see [Warranty](#) and [Terms & Conditions](#).



CATALOGUE #		FIXTURE INFO
PROJECT NAME		
CITY		
PREPARED BY	DATE	
COMMENTS		
		QUANTITY
		EPA (sq.ft.)
		WEIGHT (lbs)

Catalogue #	Pole Height (ft)	Pole Weight (lbs)	Anchor Bolt Diameter (in)	Base Plate Type	Maximum EPA (sq.ft.)			
					80MPH	90MPH	100MPH	110MPH
NRT10	10	102	1	A	48.5	38.5	30.5	25.0
NRT12	12	114	1	A	41.0	32.0	25.5	21.0
NRT14	14	123	1	A	34.5	27.0	21.5	17.5
NRT16	16	134	1	A	29.5	23.0	18.0	14.5
NRT18	18	143	1	A	25.0	19.5	15.5	12.0
NRT20	20	178	1	B	30.5	23.5	18.5	14.5
NRT22	22	187	1	B	26.5	20.5	16.0	12.5
NRT24	24	198	1	B	23.0	17.5	13.5	10.5
NRT26	26	208	1	B	20.5	15.5	12.0	9.0
NRT28	28	250	1	C	24.5	18.5	14.0	10.5
NRT30	30	259	1	C	22.0	16.5	12.5	9.0
NRT32	32	268	1	C	19.5	14.5	10.5	8.0
NRT34	34	278	1	C	17.5	12.5	9.0	6.5
NRT36	36	355	1	D	20.5	15.0	10.5	7.5
NRT38	38	364	1	D	18.5	13.0	9.5	6.5
NRT39	39	369	1	D	17.5	12.5	8.5	6.0

Order Entry Info					
HEIGHT (ft)	MOUNTING TYPE <i>(See Note 1)</i>	FINISH TYPE	PC COLOUR	OPTIONS <i>(Click descriptions to view product)</i>	
10	 TOP TENON MOUNT TT238 - 2 3/8" x 5" tenon TT278 - 2 7/8" x 5" tenon TT350 - 3 1/2" x 5" tenon	PC - Powder Coated	WHT - White (RAL-9003)	<input type="checkbox"/> DUPR - 1110 Box Provision (Festoon Box) <input type="checkbox"/> DUPRGFI - 1110 Box Provision c/w 15A 120V GFI Receptacle and Weatherproof Cover <input type="checkbox"/> HHSS - Hand Hole Security System <input type="checkbox"/> FBA1 - Flower Basket Arm One Side <i>(See Note 2)</i> <input type="checkbox"/> FBA2 - Flower Basket Arm Dual <i>(See Note 2)</i> <input type="checkbox"/> BA1 - Banner Arms One Side <i>(See Note 3)</i> <input type="checkbox"/> BA2 - Banner Arms Dual <i>(See Note 3)</i> <input type="checkbox"/> AB - Anchor Bolts <input type="checkbox"/> BH - Bullhorns <input type="checkbox"/> N - None	
12		 SIDE TENON MOUNT <i>Dimensions: 2 3/8" dia. x 5" long</i> ST1 - Single Head ST2180 - 2 Heads at 180 ST290 - 2 Heads at 90 ST390 - 3 Heads at 90 ST3120 - 3 Heads at 120 ST490 - 4 Heads at 90	NTPC - Nova Tuff Powder Coated <i>(Colour Chart)</i>		BLK - Black (BK50)
14			 DRILL PATTERN DP1 - Single Head DP2180 - 2 Heads at 180 DP290 - 2 Heads at 90 DP390 - 3 Heads at 90 DP3120 - 3 Heads at 120 DP490 - 4 Heads at 90		GALV - Galvanized
16	GALVPC - Galvanized and Powder Coated GALVNT - Galvanized and Nova Tuff Powder Coated <i>For PC or GALVPC, please select Colour from next column</i>				GRY - Grey (RAL-7040)
18					GRN - Green (RAL-6005)
20	N - None				CC - Custom Colour (RAL-) <i>(Additional charges may apply)</i>
22			<i>For Nova Tuff, please provide RAL# under CC</i>		
24					
26					
28					
30					
32					
34					
36					
38					
39					
Height	Mounting	Finish Type	PC Colour	Options	
NRT					

Note 1: Please provide fixture cutsheet.

Note 2: Please provide basket weight, arm length and mounting height.

Note 3: Please provide banner size and mounting height.

Sample Catalogue #: NRT20-ST1-GALVPC-BLK-HHSS-BA1

Reset Order Entry Form