

## Newport

### 2.5m Newport Arm

Part #: [S15-40-25NT-001](#)

TOTAL WEIGHT (KG): 26.82

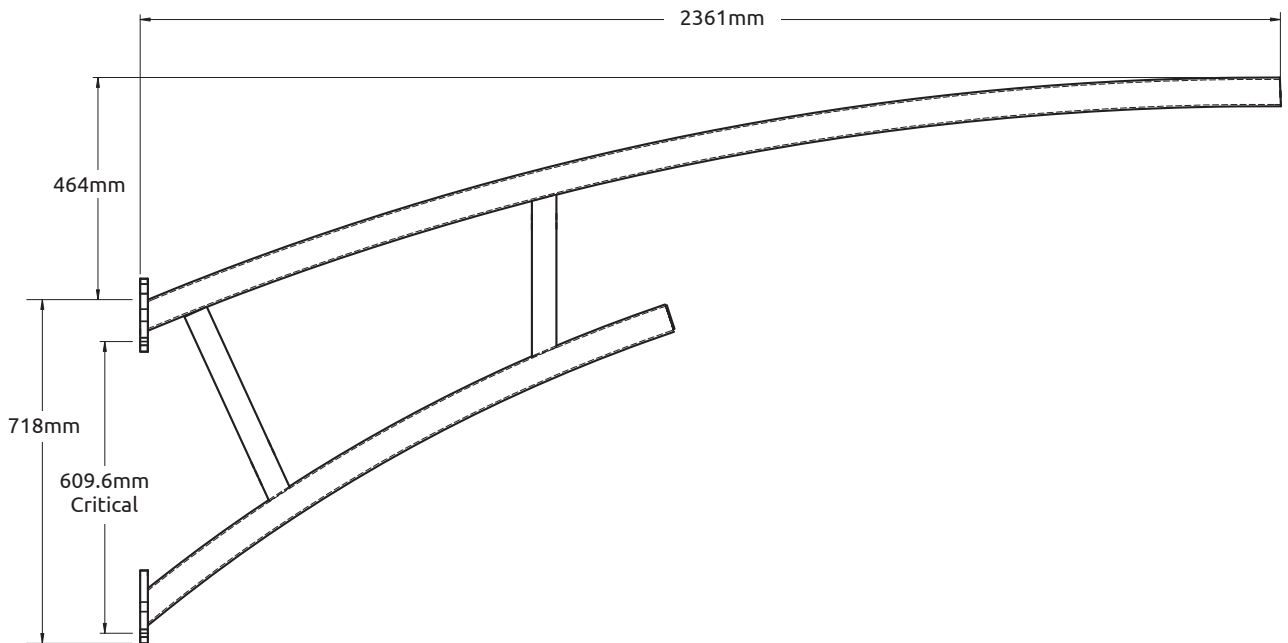
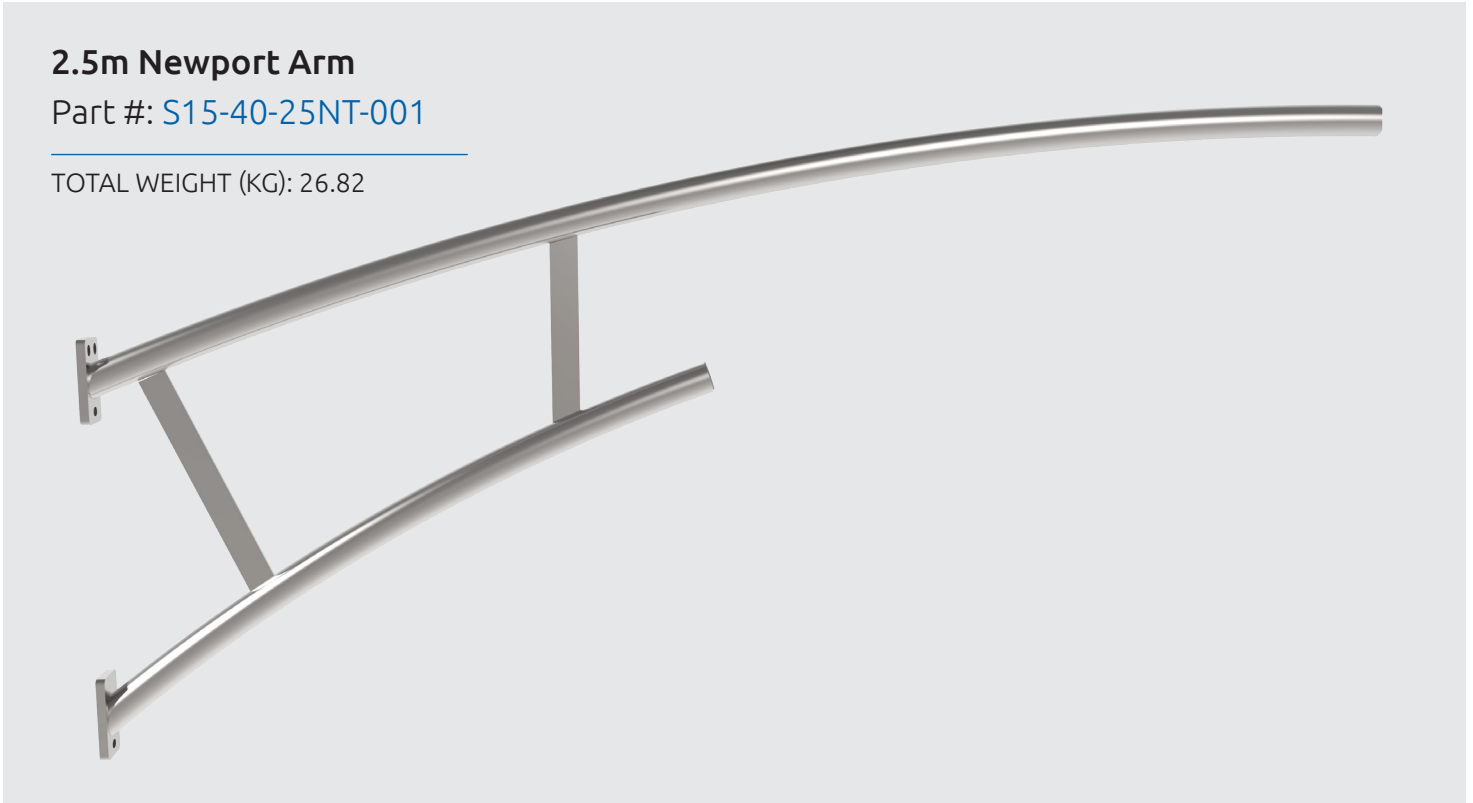

# Size Chart

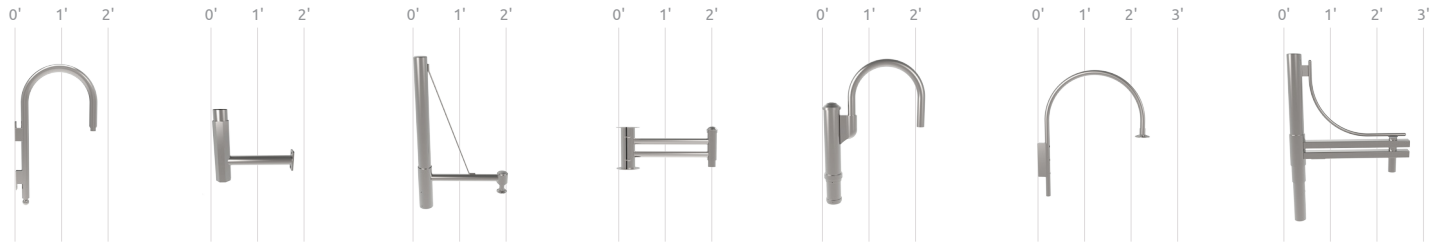

**Shepherd 2**

**Westminster**

**Long Bay**

**Ponderosa**

**Shepherd 3**

**Shepherd 1**

**Marina**

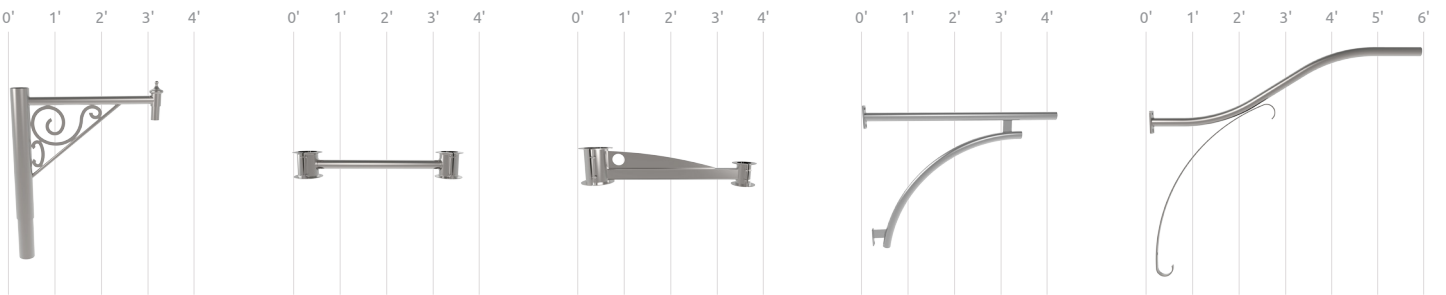

**Vernon**

**Burke**

**Riverside**

**Heritage**

**Hodgson**

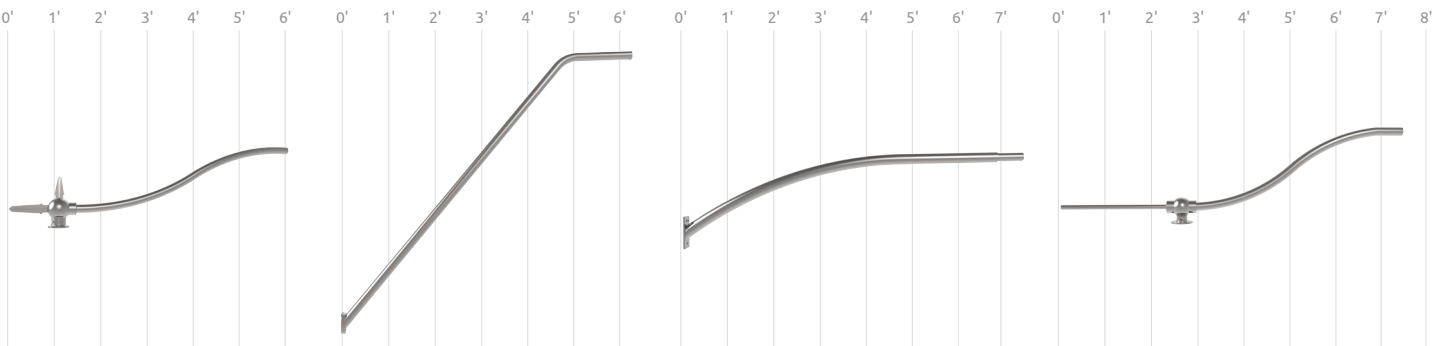

**Scroll 2**

**Kansas**

**Lima**

**Bronte**

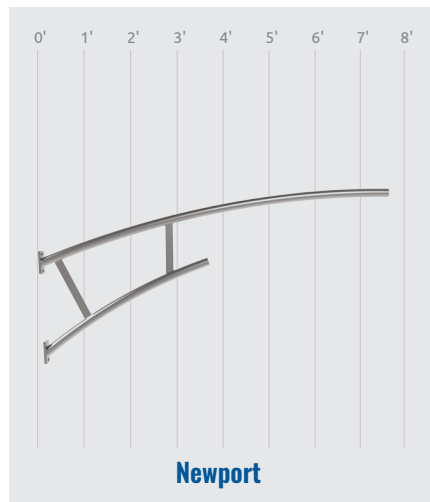

**Newport**

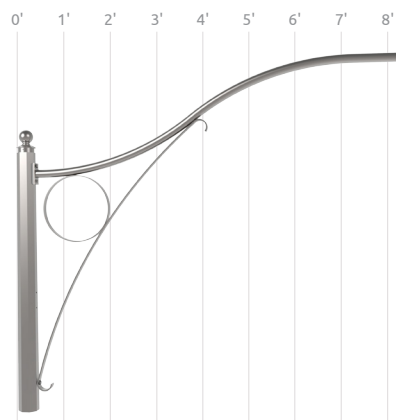

**Scroll 1**

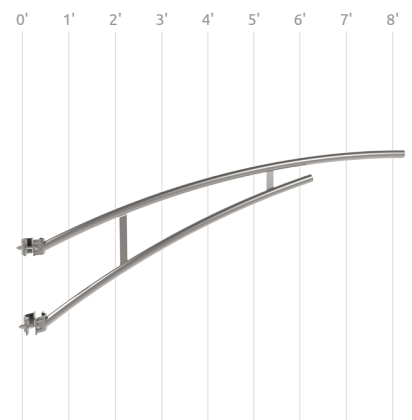

**Truss 1**

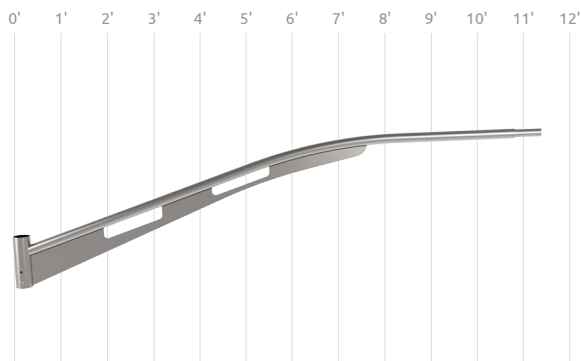

**Gullwing**

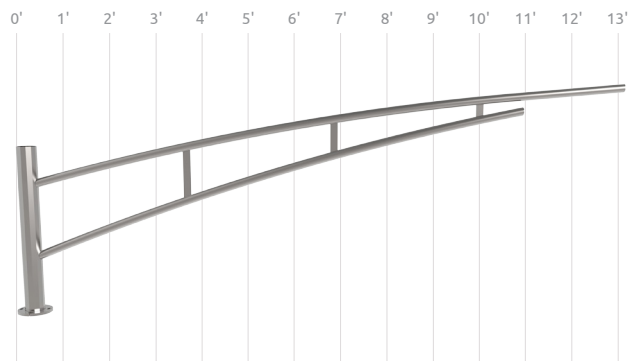

**Truss 2**